



Moduflex Proportional Regulator

1/4" and 1/2" ported

Man-machine interface

High visibility LED display
Easy to read characters
All controls on the same face

Total flexibility

User friendly and easily accessible software
One basic unit suits all customer requirements

Special applications

Clean line design
Forced exhaust
Side exhaust

Compact & light weight

Small envelope
Light weight

Flexible mounting options

Stand-alone
Foot bracket mounting
DIN-rail mounting
Modular mounting to Moduflex Air Prep

Energy Saving

Low Watt Power Consumption
No Unnecessary Loss of Air in Steady State



Outstanding performance

Very fast response times
Full flow exhaust
Excellent linearity

Generic Industries



The Moduflex Proportional Regulators are designed to quickly and accurately adjust and maintain a set output pressure.

The unit will operate regardless of flow, in response to an electronic control signal. The medium can be compressed air or an inert gas.

Applications for this technology are virtually unlimited; from paint spray control, paper manufacture and printing to weaving and laser cutting control; in fact anywhere that requires accurate remote pressure control.

Automation

In the field of general automation, the need to control processes or movement via electronic signals is of paramount importance. This new unit provides the facility to incorporate pressure control into a fully integrated control system.



Packaging and Food



The Packaging and Food industry provides another ideal area for application of the Electronic Proportional Regulator, where fine control of tension on wrapping foils and paper is required. The degree of control and the ability to manually change parameters makes this unit ideally suited to the varying requirements of this industry.

Automotive

Applications for this innovative product in the Automotive industry can be seen in major manufacturers 'body-in-white' lines.

The control of clamping and welding forces during panel assembly is an ideal application, also accurate control in paint dipping and spraying can be achieved



Why proportional technology ?

The difference between open or closed circuit control

Standard pressure regulators, designed as part of our FRL series go a long way towards meeting our customers needs. In most cases these regulators work well in general pneumatic and automation applications. However, sometimes the application calls for more precise pressure control. The effects of time, cycling, input, back pressure or pressure and flow variation can all cause inconsistencies in pneumatic systems. Our new Proportional Regulators are designed to eliminate those inconsistencies.

Open Control Circuit

In a normal pressure regulated control system, the inlet pressure (p_1) is converted into the output pressure (p_2) by the regulator. The set pressure (set value) is usually manually set by adjusting the control knob and in normal circumstances the regulator maintains the output pressure (actual value). No facility for monitoring the output pressure is provided and there is consequently no way of checking that the set value and the actual value are the same. Also, no account is taken of external influences such as air consumption by the system, which can drastically alter the actual value.

Typical application in automotive body in white welding pressure control

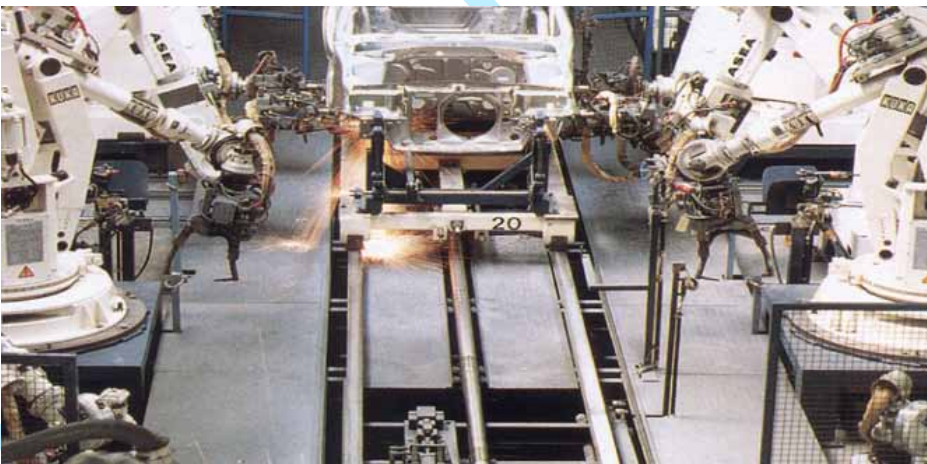

Closed Loop Control Circuit

The input signal (set value) is converted into the output value (actual value) - as in control systems but this output value is continuously measured and compared with the input signal. If they are different, the regulation unit intervenes and adjusts the output value to correspond to the set value.

Proportional Pressure Regulators

The unit provides all the advantages of a closed circuit regulated system. When a set value is defined via the input signal (e.g. 0-10V), the pressure regulator sets the corresponding output pressure (e.g. 0-10 bar). At the same time the integrated pressure sensor measures the actual pressure at the unit's outlet (actual value).

If the electronic regulation system finds that the actual value has deviated from the set value, it immediately corrects the actual value. This is a continuous process ensuring fast, accurate pressure regulation.

- Very fast response times
- Accurate output pressure
- Micro parameter settings
- Selectable I/O parameters
- Quick, full flow exhaust
- LED display indicates output pressure
- No air consumption in steady state
- Multiple mounting options
- Protection to IP65



Order Key

P	3	N	A	1	A	2	1	A
----------	----------	----------	----------	----------	----------	----------	----------	----------

Series	H Moduflex 40 (1/4") K Moduflex 60 (1/2")
Port type	1 G Thread (BSP) 9 NPT Thread
Port size	2 1/4 4 1/2
Version	A Bottom exhaust B Side exhaust E Forced exhaust *
Pressure Range	Z 0 - 2 bar S 0 - 7 bar D 0 - 10 bar
Power supply	2 24 volts
Control Signal	A 4-20mA V 0-10 V
Output Signal	D Digital, PNP (1) P PNP or 0-10V (2) N NPN or 0-10V (3) M 4-20mA fixed (4)
Input connector	1 M12 (4 pin)

On request
* When the supply voltage is lost the unit will automatically exhaust the regulated pressure to 0 bar (atmospheric pressure)

- 1) Digital PNP output only, no analogue output selectable
- 2) Digital PNP and analogue 0-10V outputs selectable, by means of parameter 6. (Factory default 0-10V)
- 3) Digital NPN and analogue 0-10 V outputs selectable by means of parameter 6. (Factory default 0-10V)
- 4) Analogue 4-20mA output only.

Note: On all analogue outputs the F.S. value can be adjusted by means of parameter 8

P3HNA Mounting brackets

Order Code	Description
P3HKA00ML	L-Bracket mounting kit
P3HKA00MC	Foot bracket mounting kit

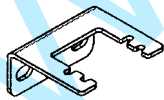

L-Bracket

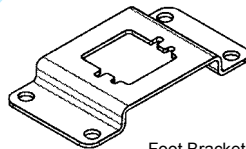

Foot Bracket

P3KNA Mounting brackets

Order Code	Description
P3KKA00ML	L-Bracket mounting kit
P3KKA00MC	Foot bracket mounting kit



L-Bracket

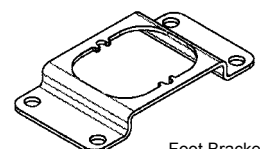

Foot Bracket

Cables

Order Code	Description
P8L-MC04A2A-M12	2 mtr. cable with moulded straight M12x1 connector
P8L-MC04R2A-M12	2 mtr. cable with moulded 90 degree M12x1 connector.

Popular Options

Port Size	Order Code	Control Signal	Output Signal	Output Pressure
G1/4	P3HNA12AS2VD1A	0-10 V	Digital, PNP only	0 - 7 bar
G1/4	P3HNA12AZ2VD1A	0-10 V	Digital, PNP only	0 - 2 bar
G1/4	P3HNA12AD2VD1A	0-10 V	Digital, PNP only	0 -10 bar
G1/4	P3HNA12AS2AD1A	4-20Ma	Digital, PNP only	0 - 7 bar
G1/4	P3HNA12AZ2AD1A	4-20Ma	Digital, PNP only	0 - 2 bar
G1/4	P3HNA12AD2AD1A	4-20Ma	Digital, PNP only	0 -10 bar
G1/4	P3HNA12AS2AP1A	4-20Ma	Digital, PNP or 0-10V	0 - 7 bar
G1/4	P3HNA12AZ2AP1A	4-20Ma	Digital, PNP or 0-10V	0 - 2 bar
G1/4	P3HNA12AD2AP1A	4-20Ma	Digital, PNP or 0-10V	0 -10 bar
G1/4	P3HNA12AS2AN1A	4-20Ma	Digital, NPN or 0-10V	0 - 7 bar
G1/4	P3HNA12AZ2AN1A	4-20Ma	Digital, NPN or 0-10V	0 - 2 bar
G1/4	P3HNA12AD2AN1A	4-20Ma	Digital, NPN or 0-10V	0 -10 bar
G1/4	P3HNA12AS2AM1A	4-20Ma	4-20mA, analogue only	0 - 7 bar
G1/4	P3HNA12AZ2AM1A	4-20Ma	4-20mA, analogue only	0 - 2 bar
G1/4	P3HNA12AD2AM1A	4-20Ma	4-20mA, analogue only	0 - 10 bar
G1/4	P3HNA12AS2VP1A	0-10 V	Digital, PNP or 0-10V	0 - 7 bar
G1/4	P3HNA12AZ2VP1A	0-10 V	Digital, PNP or 0-10V	0 - 2 bar
G1/4	P3HNA12AD2VP1A	0-10 V	Digital, PNP or 0-10V	0 -10 bar
G1/4	P3HNA12AS2VN1A	0-10 V	Digital, NPN or 0-10V	0 - 7 bar
G1/4	P3HNA12AZ2VN1A	0-10 V	Digital, NPN or 0-10V	0 - 2 bar
G1/4	P3HNA12AD2VN1A	0-10 V	Digital, NPN or 0-10V	0 -10 bar
G1/4	P3HNA12AS2VM1A	0-10 V	4-20mA, analogue only	0 - 7 bar
G1/4	P3HNA12AZ2VM1A	0-10 V	4-20mA, analogue only	0 - 2 bar
G1/4	P3HNA12AD2VM1A	0-10 V	4-20mA, analogue only	0 - 10 bar
G1/2	P3KNA14AS2VD1A	0-10 V	Digital, PNP only	0 - 7 bar
G1/2	P3KNA14AZ2VD1A	0-10 V	Digital, PNP only	0 - 2 bar
G1/2	P3KNA14AD2VD1A	0-10 V	Digital, PNP only	0 -10 bar
G1/2	P3KNA14AS2AD1A	4-20Ma	Digital, PNP only	0 - 7 bar
G1/2	P3KNA14AZ2AD1A	4-20Ma	Digital, PNP only	0 - 2 bar
G1/2	P3KNA14AD2AD1A	4-20Ma	Digital, PNP only	0 -10 bar
G1/2	P3KNA14AS2AP1A	4-20Ma	Digital, PNP or 0-10V	0 - 7 bar
G1/2	P3KNA14AZ2AP1A	4-20Ma	Digital, PNP or 0-10V	0 - 2 bar
G1/2	P3KNA14AD2AP1A	4-20Ma	Digital, PNP or 0-10V	0 -10 bar
G1/2	P3KNA14AS2AN1A	4-20Ma	Digital, NPN or 0-10V	0 - 7 bar
G1/2	P3KNA14AZ2AN1A	4-20Ma	Digital, NPN or 0-10V	0 - 2 bar
G1/2	P3KNA14AD2AN1A	4-20Ma	Digital, NPN or 0-10V	0 -10 bar
G1/2	P3KNA14AS2AM1A	4-20Ma	4-20mA, analogue only	0 - 7 bar
G1/2	P3KNA14AZ2AM1A	4-20Ma	4-20mA, analogue only	0 - 2 bar
G1/2	P3KNA14AD2AM1A	4-20Ma	4-20mA, analogue only	0 - 10 bar
G1/2	P3KNA14AS2VP1A	0-10 V	Digital, PNP or 0-10V	0 - 7 bar
G1/2	P3KNA14AZ2VP1A	0-10 V	Digital, PNP or 0-10V	0 - 2 bar
G1/2	P3KNA14AD2VP1A	0-10 V	Digital, PNP or 0-10V	0 -10 bar
G1/2	P3KNA14AS2VN1A	0-10 V	Digital, NPN or 0-10V	0 - 7 bar
G1/2	P3KNA14AZ2VN1A	0-10 V	Digital, NPN or 0-10V	0 - 2 bar
G1/2	P3KNA14AD2VN1A	0-10 V	Digital, NPN or 0-10V	0 -10 bar
G1/2	P3KNA14AS2VM1A	0-10 V	4-20mA, analogue only	0 - 7 bar
G1/2	P3KNA14AZ2VM1A	0-10 V	4-20mA, analogue only	0 - 2 bar
G1/2	P3KNA14AD2VM1A	0-10 V	4-20mA, analogue only	0 - 10 bar

- Very fast response times
- Accurate output pressure
- Micro parameter settings
- Selectable I/O parameters
- Quick, full flow exhaust
- LED display indicates output pressure
- No air consumption in steady state
- Multiple mounting options



Order Key

P	3	H	P	A	1		A			2			1	A
----------	----------	----------	----------	----------	----------	--	----------	--	--	----------	--	--	----------	----------

Port type	
1	G Thread (BSP) Female
9	NPT Thread Female

Port size	
1	1/8
2	1/4

Version	
A	Bottom exhaust
B	Side exhaust
E	Forced exhaust *

Pressure Range	
Z	0 - 2 bar
S	0 - 7 bar
D	0 - 10 bar

Power supply	
2	24 volts

Control Signal	
A	4-20mA
V	0-10 V

Output Signal		
D	Digital, PNP	1)
P	PNP or 0-10V	2)
N	NPN or 0-10V	3)
M	4-20mA fixed	4)

Input connector	
1	M12 (4 pin)

On request

* When the supply voltage is lost the unit will automatically exhaust the regulated pressure to 0 bar (atmospheric pressure)

- 1) Digital PNP output only, no analogue output selectable
- 2) Digital PNP and analogue 0-10V outputs selectable, by means of parameter 6. (Factory default 0-10V)
- 3) Digital NPN and analogue 0-10 V outputs selectable by means of parameter 6. (Factory default 0-10V)
- 4) Analogue 4-20mA output only.

Note: On all analogue outputs the F.S. value can be adjusted by means of parameter 8

P3HKA Mounting brackets

Order Code	Description
P3HKA00MK	DIN rail mounting kit
P3HKA00MF	Foot bracket mounting kit

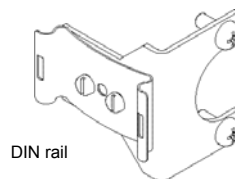

DIN rail

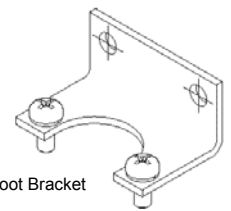

Foot Bracket

Cables

Order Code	Description
P8L-MC04A2A-M12	2 mtr. cable with moulded straight M12x1 connector
P8L-MC04R2A-M12	2 mtr. cable with moulded 90 degree M12x1 connector.

Popular Options

Port Size	Order Code	Control Signal	Output Signal	Output Pressure
G1/4	P3HPA12AZ2VD1A	0-10 V	Digital, PNP only	0 - 2 bar
G1/4	P3HPA12AS2VD1A	0-10 V	Digital, PNP only	0 - 7 bar
G1/4	P3HPA12AD2VD1A	0-10 V	Digital, PNP only	0 -10 bar
G1/4	P3HPA12AZ2VP1A	0 - 10 V	Digital, PNP or 0-10V	0 - 2 bar
G1/4	P3HPA12AS2VP1A	0 - 10 V	Digital, PNP or 0-10V	0 - 7 bar
G1/4	P3HPA12AD2VP1A	0 - 10 V	Digital, PNP or 0-10V	0 - 10 bar
G1/4	P3HPA12AZ2VN1A	0 - 10 V	Digital, NPN or 0-10V	0 - 2 bar
G1/4	P3HPA12AS2VN1A	0 - 10 V	Digital, NPN or 0-10V	0 - 7 bar
G1/4	P3HPA12AD2VN1A	0 - 10 V	Digital, NPN or 0-10V	0 -10 bar
G1/4	P3HPA12AZ2VM1A	0 - 10 V	4-20mA, analogue only	0 - 2 bar
G1/4	P3HPA12AS2VM1A	0 - 10 V	4-20mA, analogue only	0 - 7 bar
G1/4	P3HPA12AD2VM1A	0 - 10 V	4-20mA, analogue only	0 - 10 bar
G1/4	P3HPA12AZ2AD1A	4-20mA	Digital, PNP only	0 - 2 bar
G1/4	P3HPA12AS2AD1A	4-20mA	Digital, PNP only	0 - 7 bar
G1/4	P3HPA12AD2AD1A	4-20mA	Digital, PNP only	0 -10 bar
G1/4	P3HPA12AZ2AP1A	4-20mA	Digital, PNP or 0-10V	0 - 2 bar
G1/4	P3HPA12AS2AP1A	4-20mA	Digital, PNP or 0-10V	0 - 7 bar
G1/4	P3HPA12AD2AP1A	4-20mA	Digital, PNP or 0-10V	0 - 10 bar
G1/4	P3HPA12AZ2AN1A	4-20mA	Digital, NPN or 0-10V	0 - 2 bar
G1/4	P3HPA12AS2AN1A	4-20mA	Digital, NPN or 0-10V	0 - 7 bar
G1/4	P3HPA12AD2AN1A	4-20mA	Digital, NPN or 0-10V	0 -10 bar
G1/4	P3HPA12AZ2AM1A	4-20mA	4-20mA, analogue only	0 - 2 bar
G1/4	P3HPA12AS2AM1A	4-20mA	4-20mA, analogue only	0 - 7 bar
G1/4	P3HPA12AD2AM1A	4-20mA	4-20mA, analogue only	0 - 10 bar

Technical information

Pneumatics

Working medium

Compressed air or inert gasses, filtered to min. 40µ, lubricated or non-lubricated, dried or un-dried, pressure dewpoint 3-5°C.

Supply pressure

Max. Operating Pressure:
 2 bar unit: 3 bar (43.5 PSI)
 7 bar unit: 10.5 bar (152 PSI)
 10 bar unit: 10.5 bar (152 PSI)
 Min. Operating Pressure P2 Pressure + 0,5 bar (7.3 PSI)

Pressure control range

Available in three pressure ranges, 0-2 bar, 0-7 bar or 0-10 bar. Pressure range can be changed through the software at all times. (parameter 19)

Temperature range

0°C up to +50°C (32°F up to 122°F)

Weights:

P3HP = 285 g
 P3HN = 291 g
 P3KN = 645 g

Air consumption

No consumption in stable regulated situation.

Display

The regulator is provided with a digital display, indicating the output pressure, either in BAR or PSI. The factory setting is as indicated on the label, can be changed through to software at all times (parameter 14).

Electronics

Supply voltage

24 VDC +/- 10%

Power consumption

Max. 1.1W with unloaded signal outputs

Control signals

The electronic pressure regulator can be externally controlled through an analogue control signal of either 0-10V or 4-20mA.(parameter 4).

Output signals

As soon as the output pressure is within the signal band a signal is given of 24V DC, PNP Ri = 1 kOhm. Outside the signal band this connection is 0V.

Connections

(In case of output signal (option D))

Central M12 connector 4-pole

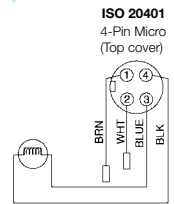

The electrical connections are as follows:

Pin no.	Function	Colour
1	24V supply	brown
2*	0-10V* control signal Ri = 100 kOhm	white
3	0V (GND) supply	blue
4	24V alarm output signal	black

* In case of 4-20 mA the Ri will be 500 Ohm.

Schematic

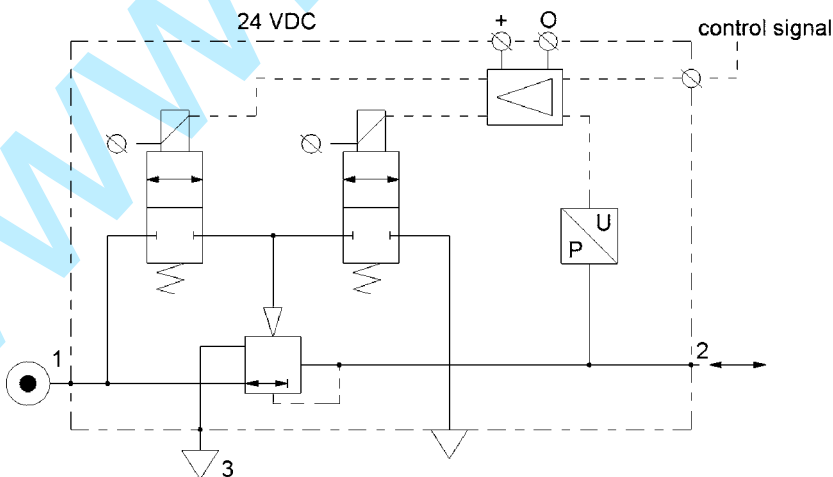

Technical information

Dead band

The dead band is preset at 1,3% F.S.
(parameter 13).

Accuracy

Linearity: = < 0,3% F.S.

Proportional band

The proportional band is preset at 10% F.S.

Fail safe operation

After interrupting the **power supply** the present output pressure is maintained at approximately the same level. After switching on the power supply again the pressure can be adjusted immediately by giving a new control signal.

Full exhaust

Complete exhaust of the regulator is defined as $P2 \leq 1\%$ F.S.

Full scale (F.S.)

For 2 bar versions this will 2 bar, for the 7 and 10 bar version full scale will be 10 bar.

EU conformity

CE: standard

EMC: according to directive 89/336/EEC

The new pressure regulator is in accordance with:

EN 61000-6-1:2001
EN 61000-6-2:2001
EN 61000-6-3:2001
EN 61000-6-4:2001

These standards ensure that this unit meets the highest level of EMC protection.

Mounting position

Preferably vertically, with the cable gland on top.

Materials: P3HN & P3KN Versions

- Magnet CoreSteel
- Solenoid Valve Poppet FPM
- Solenoid Valve Housing Techno Polymer
- Regulator Body (P3HN & P3KN versions) Aluminium
- Regulator Top Housing Nylon
- Valve headBrass & NBR
- Remaining Seals NBR

Materials: P3HP Versions

- Magnet CoreSteel
- Solenoid Valve Poppet FPM
- Solenoid Valve Housing Techno Polymer
- Valve Polyurethane
- Seats and Auxilliary Piston Delrin, Brass
- Remaining Seals NBR
- Port Connections Brass
- Regulator Top HousingABS

Advanced functionality

Pilot valve protection

When the required output pressure can not be achieved because of a lack of input pressure the unit will open fully and will display NoP. Approximately every 10 seconds the unit will retry. The output pressure will then be approximately equal to the inlet pressure. As soon as the input pressure is back on the required level, the normal control function follows.

Safety exhaust

Should the **control signal** fall below 0,1 volts the valve will automatically dump downstream system pressure .

Fail safe

When the supply voltage drops, the electronic control reverts to the fail safe mode. The last known output pressure is maintained at approximately the same level depending upon air consumption. The digital display indicates the last known pressure setting.

When the supply voltage is reinstated to the correct level, the valve moves from the fail safe mode and the output pressure immediately follows the control signal requirement.

The display indicates the actual output pressure.

Input protection

The unit has built-in protection against failure and burnout resulting from incorrect input value, typically:

The 24v DC supply is incorrectly connected to the setpoint input, the display will show 'OL', as an overload indication. The unit will need to be rewired and when correctly connected will operate normally.

The overload indicator 'OL' will also appear should the wrong input value be applied or the wrong input value be programmed: 4 - 20m instead of 0 - 10V. To correct this a different set point value should be input or the unit reprogrammed to correct the set point value acceptance. (via parameter 4).

	P3HP Plastic body	P3HN Aluminium body	P3KN Aluminium body
2 to 4 bar	30 msecs	25 msecs	35 msecs
1 to 6 bar	120 msecs	55 msecs	135 msecs
4 to 2 bar	60 msecs	70 msecs	85 msecs
6 to 1 bar	160 msecs	80 msecs	225 msecs

To fill volume of:
100cm³ - P3HP & P3HN
330cm³ - P3KN
connected to the outlet of the regulator.

Flow characteristics

Flow characteristics supply pressure 10 bar (150 PSI)

P3HPA Regulator 1/4" Ports

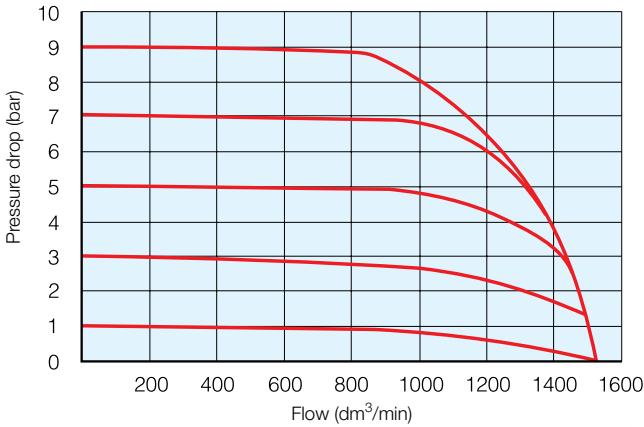

P3HNA Regulator 1/4" Ports

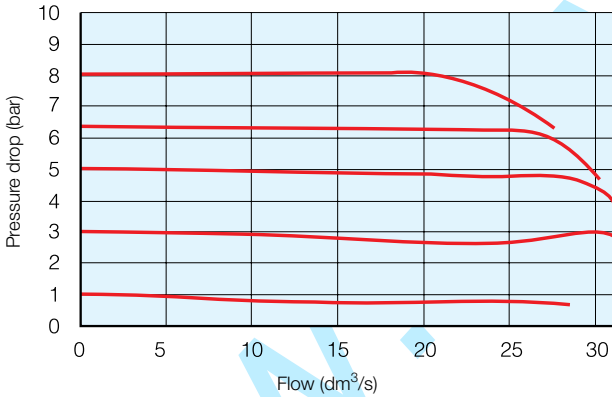

P3KNA Regulator 1/2" Ports

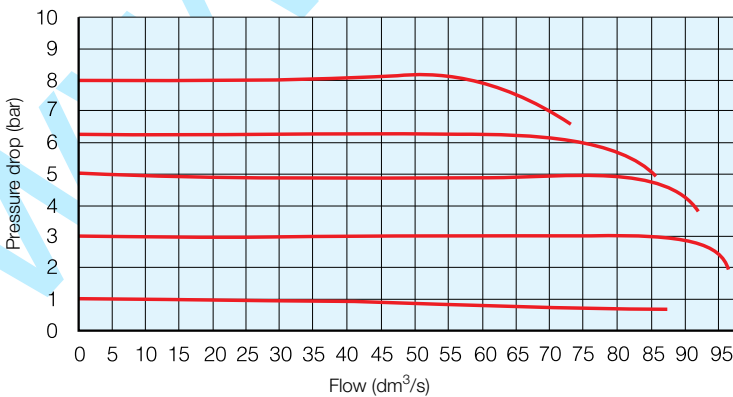

How to change parameters

Pressing the Accept key "acc" for more than 3 seconds, will activate parameter change mode. The user can then select the parameters by pressing up or down key. (display will show Pxx). When parameter number is correct, pressing accept again will enter parameter number.(display will show parameter value).

Pressing the up or down key will change the parameter itself. (display will flash indicating parameter editing mode). Pressing the accept key will accept the new parameter value. (all digits will flash whilst being accepted).

After releasing all keys , the next parameter number will be presented on the display. (you may step to the next parameter). When no key is pressed, after 3 seconds the display will show the actual output pressure.

When the unit is initially powered up allow approximately 10 seconds for the unit to "boot-up" before changing parameter settings.

Only parameter numbers 0, 4, 6, 8, 9, 14, 18, 19, 20, 12, 13 and 21 are accessible to edit. All other parameters are fixed.

Manual mode













When keys DOWN and UP are pressed during startup, (connecting to the 24V power supply) manual mode is activated. This means that the user is able to in/decrease the output pressure of the P3HP, by pressing the UP or DOWN key. During this action the display will blink, indicating that the manual mode is activated. After powering up again, the unit will revert back to normal mode.

Back to Factory Setting

After start up. (Power is on)

Entering this value in parameter 0 will store the calibrated factory data into the working parameters. (Default calibration data is used)













Parameter Number 0 – Reset Back to Factory Settings

Step	1	2	3	4	5	
Press 	 3-6 seconds					
Until Display Reads			 Flashing Decimal	 Flashing Decimal	 Flashing	
Description	Accesses changeable parameters	Accesses parameter no. 0	Displays current parameter value.	Edits parameter. 3 = standard factory settings. If other than 3, use Up or Down Arrow and accept 3	Accepts and saves new parameter setting.	Sequences to next parameter.













Set Control Signal

The unit is factory set for 0-10 V control signal. If 4-20 mA control signal is required, change parameter 4.













Parameter Number 4 – Set Control Signal in Volts or Milliamps

Step	1	2	3	4	5	
Press 	 3-6 seconds					
Until Display Reads			 Flashing Decimal	 Flashing Decimal	 Flashing	
Description	Accesses changeable parameters	Accesses parameter no. 4	Displays current parameter value. 1 = V 0 = mA	Edits parameter	Accepts and saves new parameter setting.	Sequences to next parameter.

Parameter Number 6 – Set output signal

Step	1	2	3	4	5	
Press 	 3-6 seconds					
Until Display Reads			 Flashing Decimal	 Flashing Decimal (value 0, 1 or 2)	 Flashing	
Description	Accesses changeable parameters	Accesses parameter no. 06	Displays current parameter value. 1 =m factory default for P3H with analog options	Edits parameter 0 = digital (NPN or PNP) 1 = analog 0 .. 10 V 2 = analog 4...20 mA	Accepts and saves new parameter setting.	Sequences to next parameter.













Parameter Number 8 – Adjust span analogue output signal

Step	1	2	3	4	5	
Press 	 3-6 seconds					
Until Display Reads			 Flashing Decimal (for 2 bar versions value = 92)	 Flashing Decimal (value between 0 and 130)	 Flashing	
Description	Accesses changeable parameters	Accesses parameter no. 8	Displays current parameter value.	Edits parameter	Accepts and saves new parameter setting and implements the new analog signal span	Sequences to next parameter.

Adjust Digital Display

If necessary, adjustments can be made to the digital display readout in order to match to an external pressure gauge.













Parameter Number 9 – Adjust Displayed Pressure

Step	1	2	3	4	5	
Press 	 3-6 seconds					
Until Display Reads			 Flashing Decimal	 Flashing Decimal	 Flashing	
Description	Accesses changeable parameters	Accesses parameter no. 9	Displays current digital display.	Use up or down arrows and accept, to match the readout to an external pressure gauge.	Accepts and saves new parameter setting.	Sequences to next parameter.

Set Pressure Scale

Units with NPT port threads are supplied with a factory set PSI pressure scale. Use parameter 14 to change scale to bar.













Parameter Number 14 – Set Pressure Scale in PSI or bar

Step	1	2	3	4	5	
Press 	 3-6 seconds					
Until Display Reads			 Flashing Decimal	 Flashing Decimal	 Flashing	
Description	Accesses changeable parameters	Accesses parameter no. 14	Displays current parameter value. 1 = PSI 0 = bar	Edits parameter	Accepts and saves new parameter setting.	Sequences to next parameter.

Preset Minimum Pressure

If there is a need for a pre-set minimum pressure, use parameter 18. (Note: preset pressure is affected by % P19.)

Parameter Number 18 – Set Minimum Preset Pressure

Step	1	2	3	4	5	
Press 	 3-6 seconds					
Until Display Reads			 Flashing Decimal	 Flashing Decimal (value between 0 and 200)	 Flashing	
Description	Accesses changeable parameters	Accesses parameter no. 18	Displays current parameter value. Incremental value is: <u>2 bar unit:</u> x 2 mbar x % P19 <u>10 bar unit:</u> x 10 mbar x % P19	Edits parameter	Accepts and saves new parameter setting.	Sequences to next parameter.

Set Pressure Correction













Pressure correction allows the user to set a maximum pressure as a percentage of secondary pressure F.S.

Example: If F.S. is 10 bar, set parameter 19 to 50 for maximum preset pressure of 5 bar.

Pressure correction also affects the minimum preset pressure in parameter 18.

Example: If F.S. is 10 bar and parameter 18 is set to a value of 100 (1 bar), and parameter 19 is set to 50%, then the actual minimum preset pressure seen is 0.5 bar.

Parameter Number 19 – Set Maximum Preset Pressure













Step	1	2	3	4	5	
Press 	 3-6 seconds					
Until Display Reads			 Flashing Decimal	 Flashing Decimal (value between 0 and 100)	 Flashing	
Description	Accesses changeable parameters	Accesses parameter no. 19	Displays current parameter value. Incremental value is % of F.S.	Edits parameter	Accepts and saves new parameter setting.	Sequences to next parameter.

Behavior Control

The regulation speed of the pressure regulator can be modified by means of one parameter. (P 20)

The value in this parameter has a range from 0-5. A higher value indicates slower regulation speed, but will be more stable.

Parameter Number 20 – Set Behavior Control

Step	1	2	3	4	5	
Press 	 3-6 seconds					
Until Display Reads			 Flashing Decimal	 Flashing Decimal (value between 0 and 5)	 Flashing	
Description	Accesses changeable parameters	Accesses parameter no. 20	Displays current parameter value.	Edits parameter 0 = custom set* 1 = fastest (narrow proportional band) 2 = fast 3 = normal 4 = slow 5 = slowest (proportional band is broad)	Accepts and saves new parameter setting.	Sequences to next parameter.











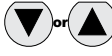

*When the value 0 is entered, you are able to create your own custom settings true parameters 12, 13 and 21.

Fine Settings

Set Proportional Band

Proportional band is used for setting the reaction sensitivity of the regulator. The displayed value is X 10 mbar and has a range between 50 (0.5 bar) and 250 (2.5 bar).











Parameter Number 12 – Set Proportional Band (P20 Must be Set to 0)

Step	1	2	3	4	5	
Press 	 3-6 seconds					
Until Display Reads			 Flashing Decimal	 Flashing Decimal (value between 50 and 250)	 Flashing	
Description	Accesses changeable parameters	Accesses parameter no. 12	Displays current parameter value. Incremental value is X 10 mbar.	Edits parameter	Accepts and saves new parameter setting.	Sequences to next parameter.

Set Deadband

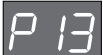
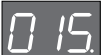











Deadband is the minimum limit of accuracy at which the regulator is set for normal operation. The displayed value is X 10 mbar and has a range between 2 (20 mbar) and 40 (400 mbar).

Parameter Number 13 – Set Deadband (P20 Must be Set to 0)







Step	1	2	3	4	5	
Press 	 3-6 seconds					
Until Display Reads			 Flashing Decimal	 Flashing Decimal (value between 4 and 40)	 Flashing	
Description	Accesses changeable parameters	Accesses parameter no. 13	Displays current parameter value. Incremental value is X 10 mbar.	Edits parameter	Accepts and saves new parameter setting.	Sequences to next parameter.

Proportional Effect

Parameter Number 21 – Set Proportional Effect (P20 Must be Set to 0)

Step	1	2	3	4	5	
Press 	 3-6 seconds			 or 		
Until Display Reads			 Flashing Decimal	 Flashing Decimal (value between 5 and 100)	 Flashing	
Description	Accesses changeable parameters	Accesses parameter no. 21	Displays current parameter value.	Edits parameter 5 = fastest regulation 100 = slowest regulation	Accepts and saves new parameter setting.	Sequences to next parameter.

Parameter Number 39 – Displays Current Software Version

Step	1	2	3	
Press 	 3-6 seconds			
Until Display Reads			 Flashing Decimal	
Description	Accesses parameters	Accesses parameter no. 39	Displays current parameter value. XXX = current software version	

Troubleshooting guide

Problem	Possible Reason	Solution
Display will not light up	No 24 volts power supply	Check if the wiring is connected according to the schematic wiring diagram
Unit will not, or not correctly respond to given setpoint	Wrong current applied (I.e. Volt instead of mA or mA instead of Volt	Change setpoint current or re configure the setpoint current through the software by changing parameter 4
	Setpoint signal is not stable enough	Check wiring if the setpoint signal lead is connected to the right pin within the male M12 connector (should be pin 2) Stabilize setpoint signal input
Display shows NoP.	Unit detects that required output pressure is higher than the supplied pressure	Adjust the inlet pressure to a higher value, preferably 0,5 bar higher than requested output pressure Give lower setpoint value which corresponds to a output pressure lower than the inlet pressure
	No inlet pressure at all	Connect port 1 to the supply pressure
Unit behaviour is not considered normal	Faulty settings made in the parameters	Reset the unit to factory settings by using the green key function under parameter 0
Desired pressure can not be reached	Setpoint value to low	Increase setpoint value
	Pre-set pressure limit has been changed to a lower max. outlet pressure	Change max. outlet pressure back to required pressure by changing parameter 19
	Supply pressure is to low	Increase supply pressure
Secondary side stays pressurized	Setpoint value is higher than 0,1 Volt	Lower your setpoint value, preferably to 0 Volts
	Pre-set pressure has been enabled to a certain pressure	Reset parameter 18 to 0
Display shows unrealistic value	Display maybe configured in the wrong value (bar instead of psi)	Check through parameter 14, if the display value is set on either psi or bar, if necessary change it to the required setting
Unit response time too slow or too quick	Volume behind the unit is either too big or too small	Adjust the regulating speed of the unit through parameter 20
Unit gives too much overshoot	Relation between volume and response time is out of balance	Adjust response time to a higher value through parameter 20, to acheive more accurate behaviour
Unit is adjusting/regulating constantly	Airleakage in the system behind the unit	Resolve leakage
	Constant changing volume behind the unit	Unit needs to regulate to keep required pressure at the same level Try to minimize the volume changes
	"Deadband "area is set too small	Enlarge deadband setting through parameter 13 in the software (parameter 20 has to be set to 0 before changing parameter 13)
Can not enter software through touchpad	Unit is currently working/processing	Make sure that the unit is in steady state while activating the software
	Activating time is too short	Hold the accept button for at least 3 seconds
Display indicates 'OL'	Wiring not according to diagram (24 volt connected on the setpoint connection pin)	Rewire so that on the setpoint connection pin will be either 0-10v or 4-20mA
	Wrong setpoint value given in relation to programmed setpoint value acceptance	Change over setpoint value to either V or mA or Reprogramme the unit to the correct setpoint value via parameter 4
Any other problem		Please consult factory

Dimensional drawings P3HPA (mm)

Bottom exhaust version

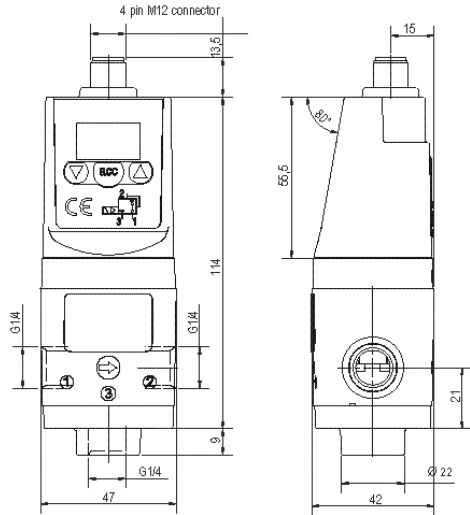

Side exhaust version

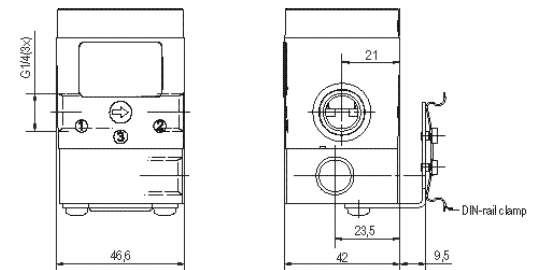
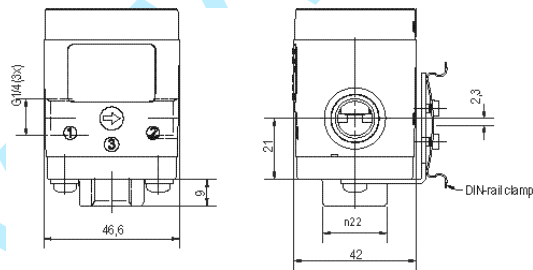
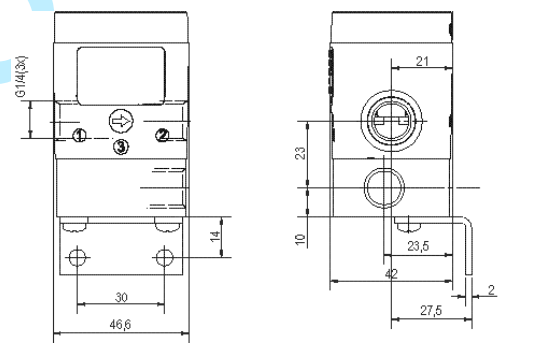
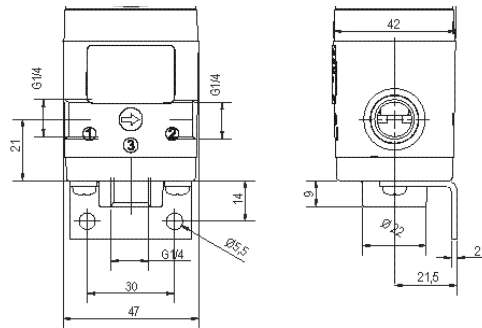
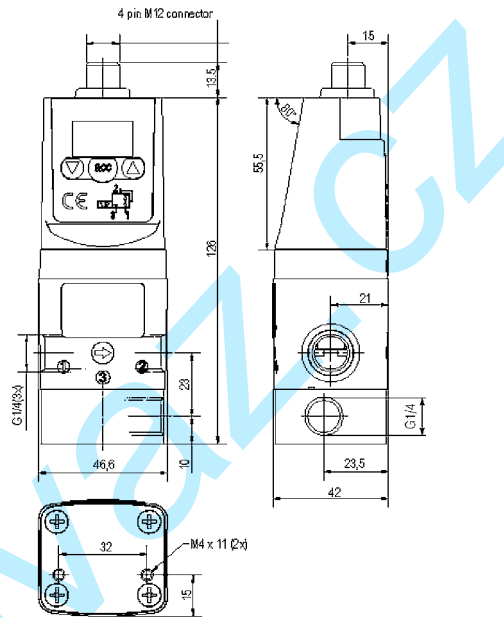

Dimensional drawings P3HNA (mm)

Bottom exhaust version

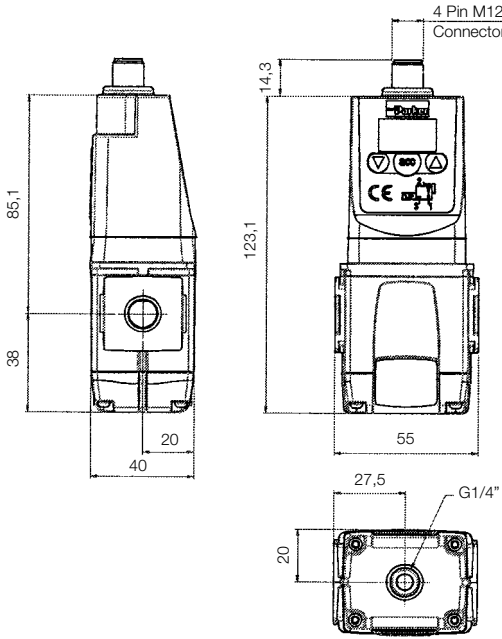

Side exhaust version

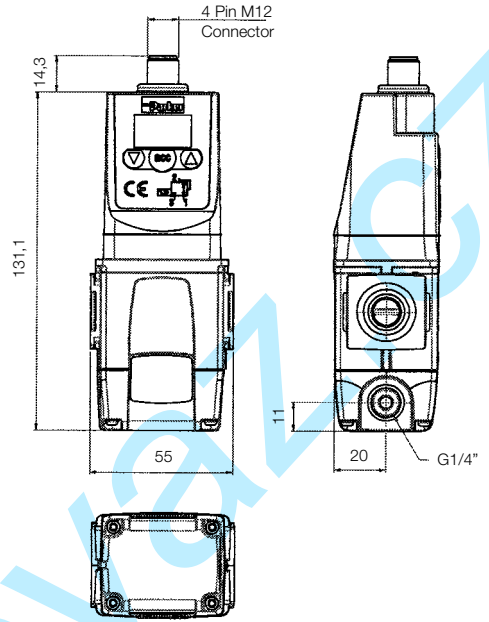

L-Bracket mounting

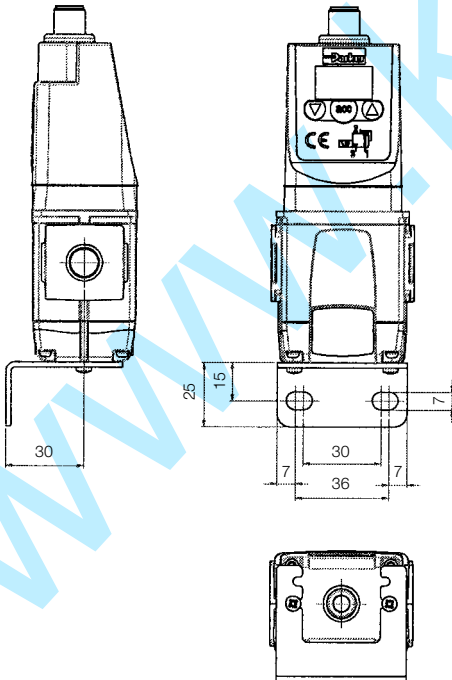

Foot bracket mounting

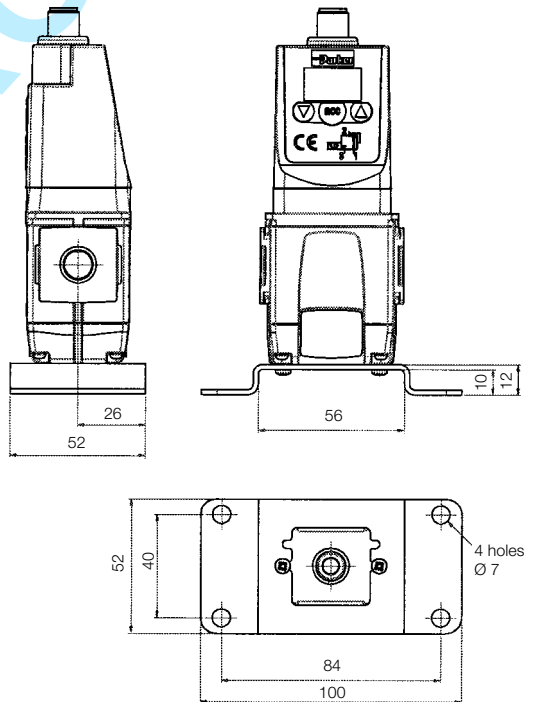

Dimensional drawings P3KNA (mm)

Bottom exhaust version

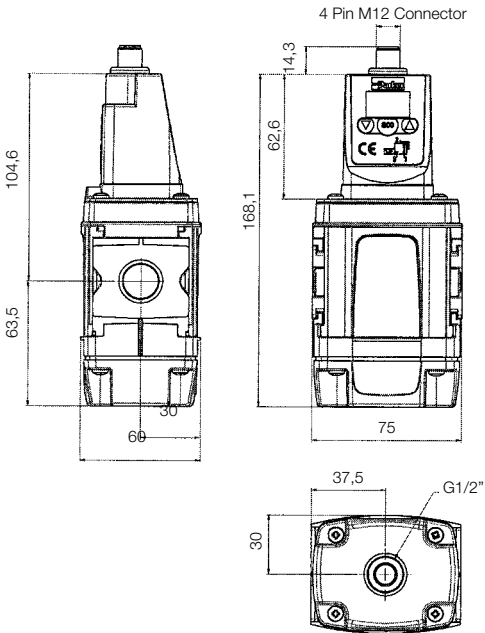

Side exhaust version

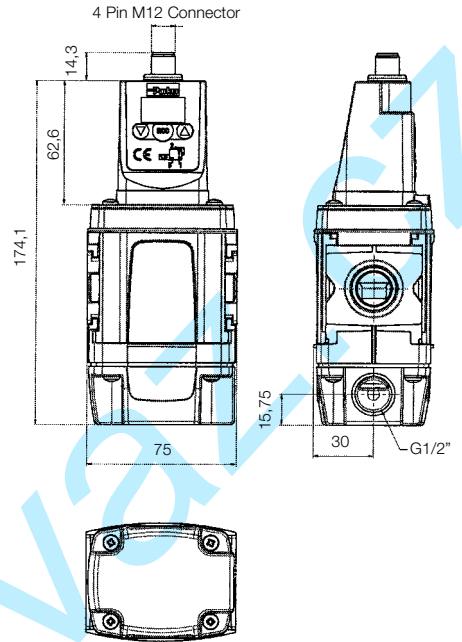

L-Bracket mounting

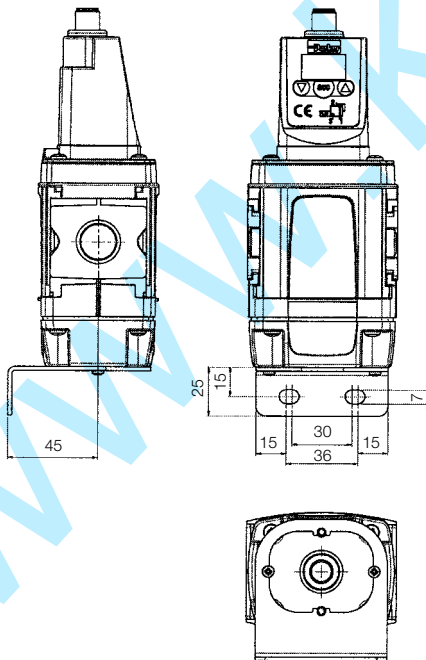

Foot bracket mounting

